

Certified Thermal Details and Products Scheme

Marmox – Thermoblock (100 mm and 140 mm blocks)

Prepared for: Mark Bowman, UK technical manager

Date: 13 August 2015

Report Number: HPR357-1002

BRE Scotland
Orion House
Scottish Enterprise Technology Park
East Kilbride, Glasgow
G75 0RD

Customer Services 0333 321 8811

Scheme Technical Manager:
T + 44 (0) 1355 576200
F + 44 (0) 1355 576210
E certifiedthermalproducts@bre.co.uk
www.bre.co.uk/certifiedthermalproduct

Prepared for:
Mark Bowman, UK technical manager
Caxton House
101
Hopewell Drive
Chatham
Kent
ME5 7NP



Prepared by

Name Graeme A. Hannah

Position Scheme Technical Manager

Date 13 August 2015

Signature

A handwritten signature in black ink, appearing to read 'GAH', written over a light grey background.

Authorised by

Name Dr Brian Anderson

Position Director, Energy

Date 13 August 2015

Signature

A handwritten signature in black ink, appearing to read 'BML', written over a light grey background.



Table of Contents

1	Introduction	3
1.1	Certified Thermal Details and Products Scheme	3
1.2	Marmox – Thermoblock (100 mm and 140 mm blocks)	3
2	Assessment	5
2.1	Thermal assessment	5
2.2	Software	5
2.3	Geometry	5
2.4	Thermal conductivities	5
3	Assessment results	6
3.1	Assessment results	6
Appendix A	Materials with heat flows and Temperature Distribution Profiles	7
Appendix B	Junction detail drawings	16



1 Introduction

1.1 Certified Thermal Details and Products Scheme

The Certified Thermal Details and Products Scheme and database will launch on the 31st of July. The data will allow users to search a range of accurate and independently assessed thermal junction details, products and elements, ensuring accuracy, consistency, credibility and quality throughout the design and specification process.

This scheme provides independent, third party assessment and certification of the 'as designed' thermal performance of:

- Building junction details (e.g. SAP Table K1 + some bespoke detail types)
- Opening products (e.g. windows, doors and rooflights)
- Major (plane) building elements (e.g. wall, roof and floor products)

This ensures that the performance, marking and classification requirements of the appropriate standards are met and maintained.

1.2 Marmox – Thermoblock (100 mm and 140 mm blocks)

Marmox have submitted the **Thermoblock (100 mm and 140 mm variations)** within junction details to BRE. These were assessed, certified and listed on the Certified Thermal Details and Products Scheme database:

www.bre.co.uk/certifiedthermalproducts

Ψ -value (W/m²·K) and temperature factor (f) calculations were undertaken for the junction details as follows:

- Cavity wall (100 mm and 140 mm variations)
 - Slab on ground (insulation above slab)
 - Beam and block
 - Suspended timber frame
- Timber frame (140 mm only)
 - Slab on ground (insulation above slab)
 - Suspended timber frame

The quantity which describes the heat loss associated with a thermal bridge is its linear thermal transmittance, ψ . This is a property of a thermal bridge and is the rate of heat flow per degree per unit length of the bridge, that is not accounted for in the U-values of the plane building elements containing the thermal bridge

The temperature factor (f) is used to assess the risk of surface condensation or mould growth and is calculated under steady state conditions. To avoid problems of surface condensation or mould growth,



the f_{Rsi} should not be less than a critical temperature factor (f_{CRsi}). A range of appropriate critical temperature factors, as identified in BRE Information Paper IP 1/06, are detailed in Table 1 below:

Type of Building	Critical Temperature Factor (f_{CRsi})
Storage Buildings	0.30
Offices, retail premises	0.50
Dwellings, residential buildings, schools	0.75
Sports halls, kitchens, canteens	0.80
Swimming pools, laundries, breweries	0.90

Recommended Critical Temperature Factors

In this case, the most appropriate critical temperature factor is for dwellings / residential buildings (0.75).



2 Assessment

2.1 Thermal assessment

Thermal assessment models of junction details were created for each of the details. These were developed on the basis of information provided by the client, with representative thermal conductivities assumed for each material.

The assessments were undertaken in compliance with:

- o BR 497 Conventions for calculating linear thermal transmittance and temperature factors

2.2 Software

The assessment was undertaken using Physibel TRISCO (v 12.0) thermal modelling software.

2.3 Geometry

Within the models, the detailed geometry of the junction details were taken from drawings provided by the client, as per the detail drawings contained within Appendix B.

2.4 Thermal conductivities

The representative thermal conductivities used in the model were taken from Annex A of BS EN ISO 10077-2 and information provided the client, as detailed below in Table 1.

Material	Thermal conductivity (W/m·K)
XPS Thermoblock	0.047
Brick	0.77
Concrete block	1.13
Lightweight concrete block	0.19
Plasterboard	0.18
Timber	0.13
Mineral wool (wall)	0.032
Rigid insulation (wall)	0.023
Mineral wool (floor)	0.035
Rigid insulation (floor)	0.022
Perimeter insulation	0.022

Table 1 – Representative thermal conductivities



3 Assessment results

3.1 Assessment results

The results for the assessment of the junction detail variations are as follows:

	Manufacturer Reference	Description	Calculated Ψ-value (W/m K)	Temperature Factor
600023	100 mm XPS Thermoblock	Cavity wall-ground floor junction (insulation above slab with 100 mm Thermoblock)	0.031	0.94
600024	140 mm XPS Thermoblock	Cavity wall-ground floor junction (insulation above slab with 140 mm Thermoblock)	0.030	0.94
600025	100 mm XPS Thermoblock	Cavity wall-ground floor junction (beam and block floor with 100 mm Thermoblock)	0.038	0.95
600026	140 mm XPS Thermoblock	Cavity wall-ground floor junction (beam and block floor with 140 mm Thermoblock)	0.042	0.95
600027	100 mm XPS Thermoblock	Cavity wall-ground floor junction (suspended timber with 100 mm Thermoblock)	0.081	0.88
600028	140 mm XPS Thermoblock	Cavity wall-ground floor junction (suspended timber with 140 mm Thermoblock)	0.085	0.88
600029	140 mm XPS Thermoblock	Timber frame wall-ground floor junction (insulation above slab with 140 mm Thermoblock)	0.039	0.92
600030	140 mm XPS Thermoblock	Timber frame wall-ground floor junction (suspended timber with 140 mm Thermoblock)	0.079	0.91

Table 2 – Assessment Results

Graphics from the thermal modelling for each of the variations are given in Appendix A. This includes for:

- Geometry and heat flow
- Temperature distribution profile



Appendix A Materials with heat flows and Temperature Distribution Profiles

600023 - Cavity wall-ground floor junction (insulation above slab with 100 mm Thermoblock)

Materials and heat flow

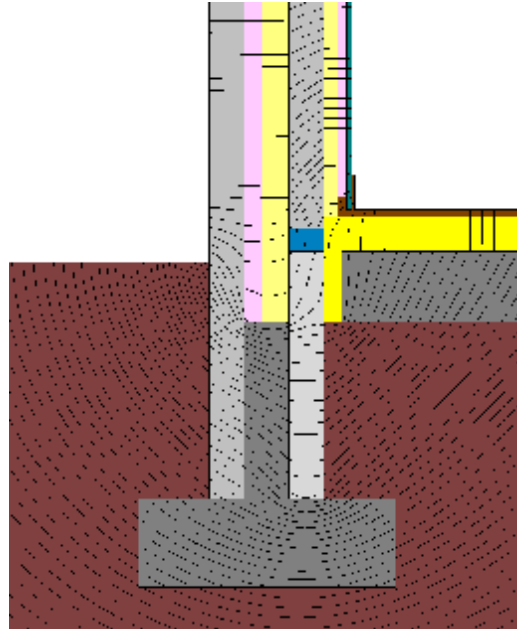

Temperature profile

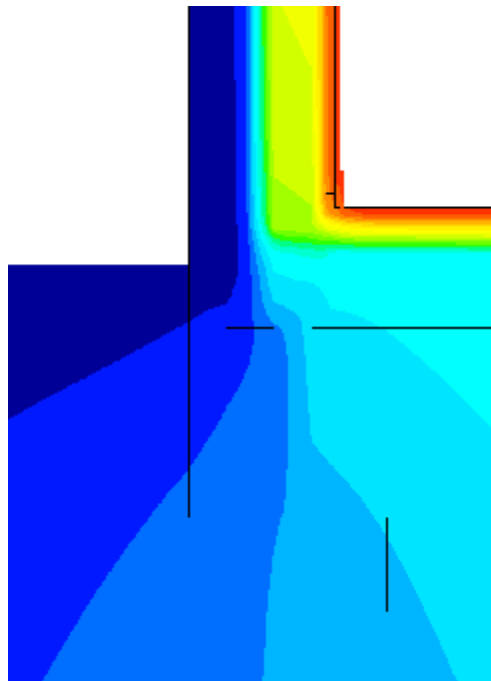

600024 - Cavity wall-ground floor junction (insulation above slab with 140 mm Thermoblock)

Materials and heat flow

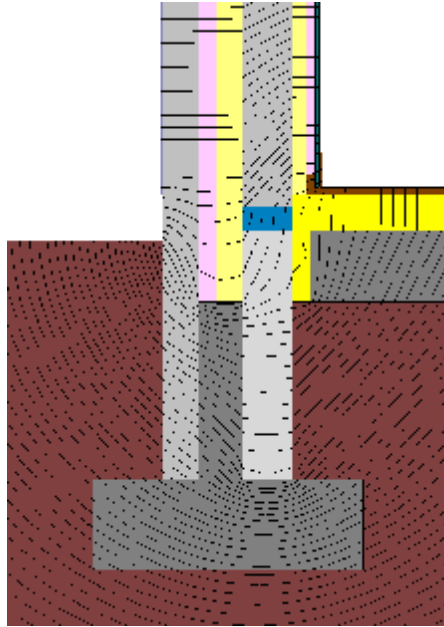

Temperature profile

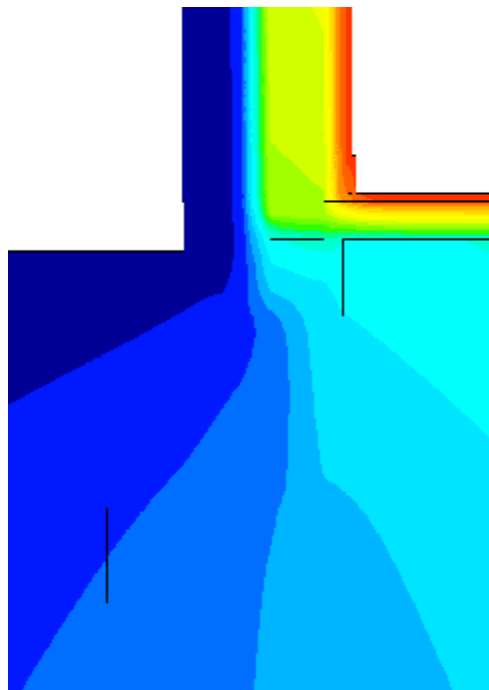



600025 - Cavity wall-ground floor junction (beam and block floor with 100 mm Thermoblock)

Materials and heat flow

-

Temperature profile

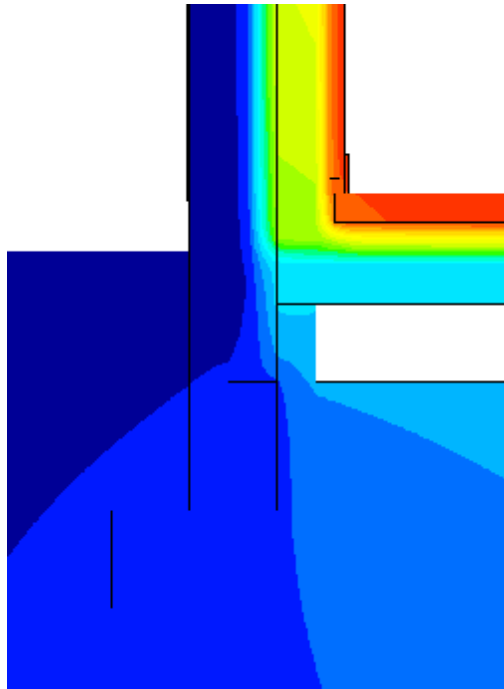



600026 - Cavity wall-ground floor junction (beam and block floor with 140 mm Thermoblock)

Materials and heat flow

-

Temperature profile

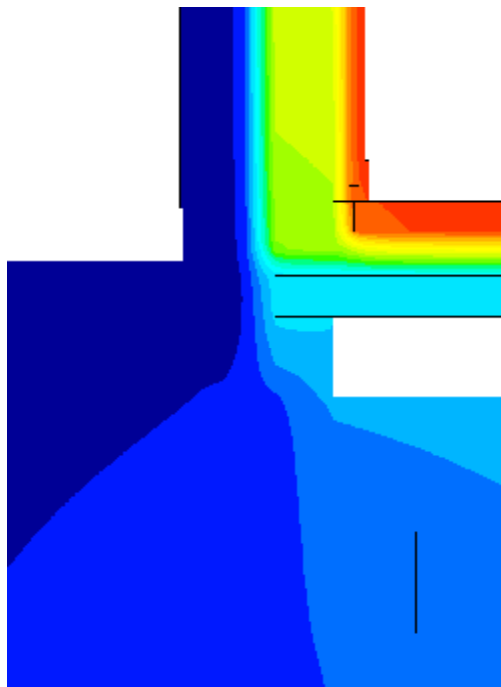

600027 - Cavity wall-ground floor junction (suspended timber with 100 mm Thermoblock)

Materials and heat flow

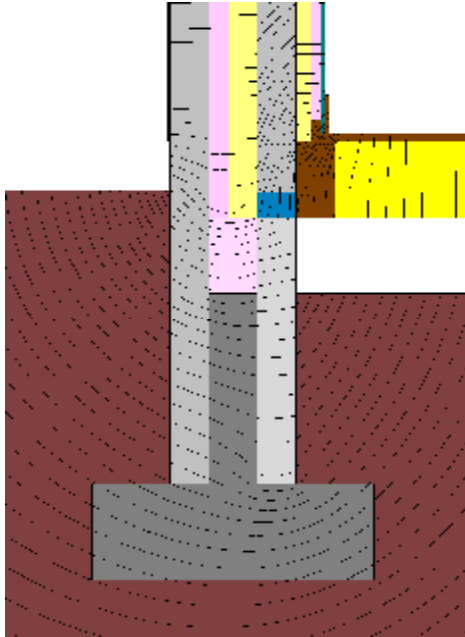

Temperature profile

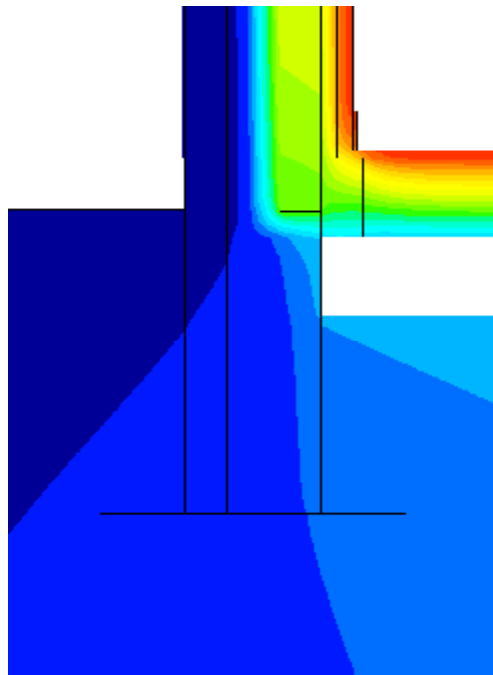



600028 - Cavity wall-ground floor junction (suspended timber with 140 mm Thermoblock)

Materials and heat flow

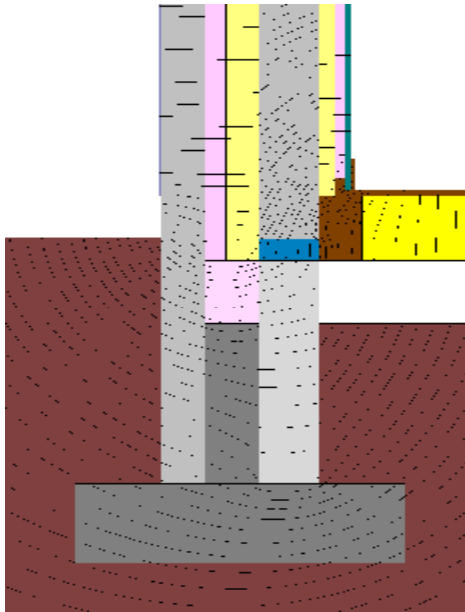

Temperature profile

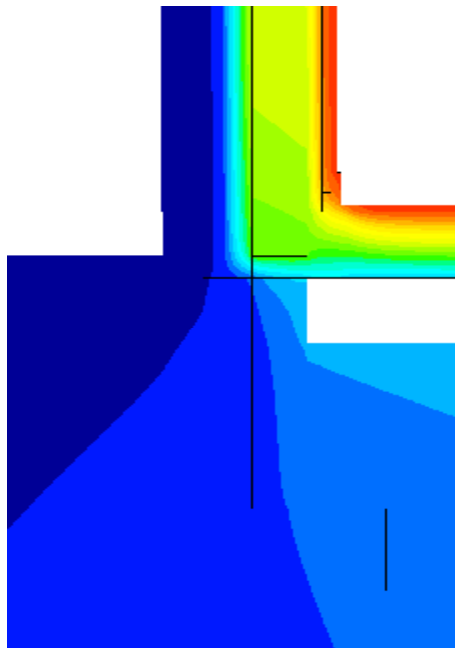

600029 - Timber frame wall-ground floor junction (insulation above slab with 140 mm Thermoblock)

Materials and heat flow

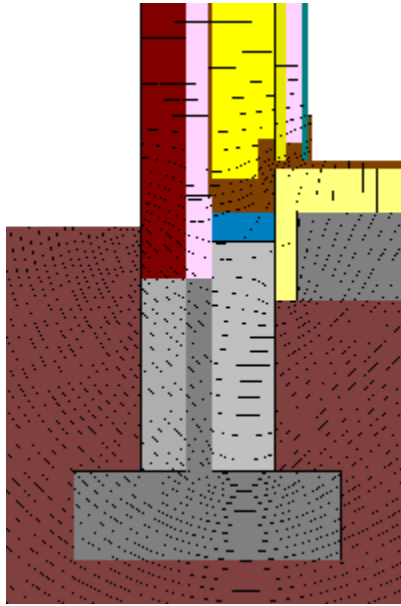

Temperature profile

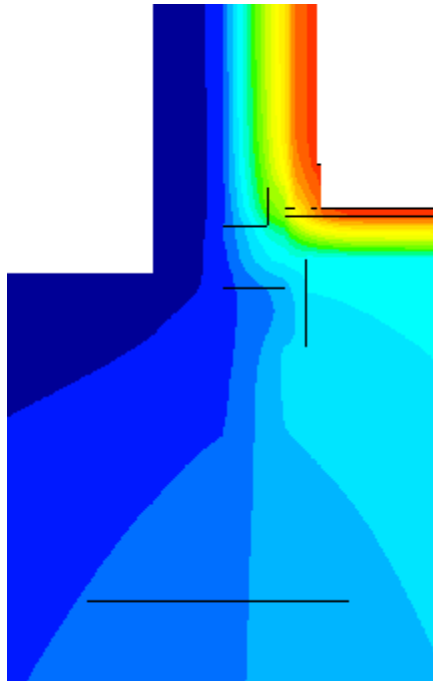

600030 - Timber frame wall-ground floor junction (suspended timber with 140 mm Thermoblock)

Materials and heat flow

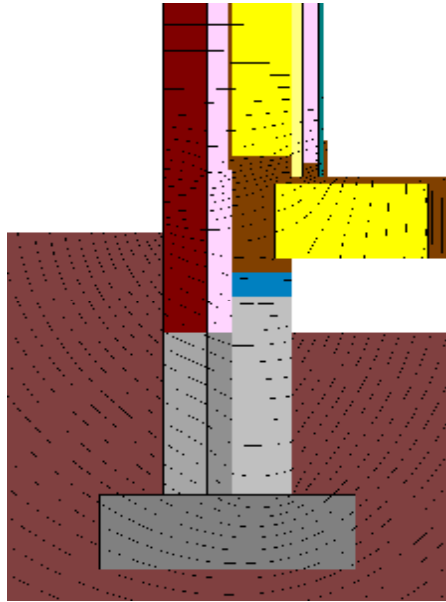

Temperature profile

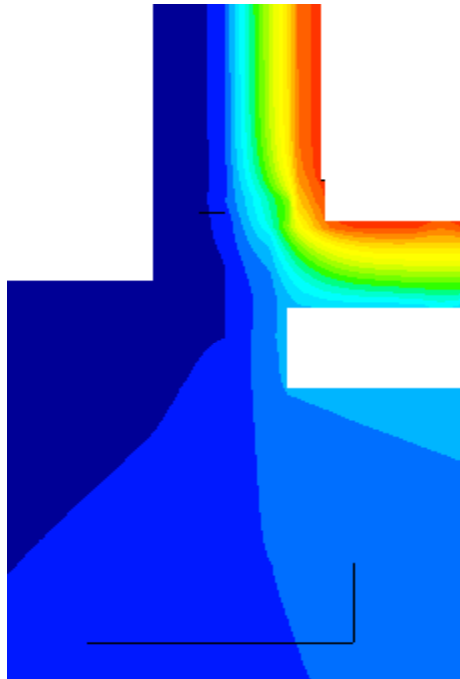



Appendix B Junction detail drawings
